

Production of a Heavy Section Ductile Iron Grinding Table

Ming You, Xiaogang Diao*

CITIC Heavy Industries Co., Ltd. Luoyang 471039, China

Production process of an extra-large ductile iron grinding table with weight of 142 t was introduced in the present paper. Solidification process of the grinding table was simulated with finite element software ProCAST. Defects, especially porosity, of the casting during solidification were predicted and hence casting process optimization has been performed based on the simulation results. In manufacturing period of the ductile iron grinding table, the following measures were adopted to avoid casting defects and improve its mechanical properties. Firstly, bottom-gated gating system was used. Secondly, chills were set on the heavy section locations. Thirdly, risers were set on the top of the casting. Besides, chemical composition was strictly controlled and raw materials with fewer impurities were used. More than 150 t molten melt was supplied using medium frequency induction furnaces. Cored wire injection nodularizing and inoculation was performed at 1360~1380°C by two ladles with capacity of 75 t. Post-inoculation was conducted during pouring as well as low temperature and fast pouring process was adopted. The qualified heavy section ductile iron grinding table product can thus be obtained. Shrinkage and porosity was evidently decreased at thermal center of the casting. The result of casting inspection showed that mechanical properties of the casting met the requirements of EN-GJS-400-15U grade nodular iron and the UT detection didn't find any casting defect exceeding grade 3 according to EN 12680-3-2003.

Keywords: Heavy Section Ductile Iron; Grinding Table; Casting Process.

Introduction

Grinding table, whether ductile iron or cast steel, is a key part of vertical mill in the cement industry, for it affects directly the service life of vertical mill. As a result of spheroidal graphite, ductile iron possesses high castability together with improved mechanical properties, and is more economical in production in compared with cast steel. Ductile iron castings have promising applications due to a fantastic growth not only in the cement industry but also in mining, metallurgy, wind mill and nuclear industry.¹⁻⁵ In recent years an increase in the thickness of the castings has been desired due to the new requirements in the weight and size of machine parts, hence it is a challenge for manufacture factory to offer heavy section and extra large ductile iron castings with high quality and reliability.^{1,6-8}

The microstructure together with solidification defects, such as shrinkage porosity of heavy section ductile iron determines its mechanical properties. There are many factors influence the microstructure and solidification defects, such as gating system, chemical composition, cooling rate, liquid treatment and heat treatment.⁹⁻¹³ Shrinkage porosity is one of the most common solidification defects.^{14,15} It is often found in spheroidal graphite iron castings because of the mushy zone and special volume change during their solidification. The presence of porosity would deteriorate mechanical properties of the casting greatly. The main reason of shrinkage formation is that all metal alloys contract when it cools from the pouring temperature to the solidus. If the contraction is not compensated by supplying feed metal from the risers or the gating system, a pore will occur. Feeding system is efficient until the amount of solid phase reaches a certain level.² Solidification defects in heavy section ductile iron have been the subject of several research projects, but it is more difficult to fabricate such a casting with no shrinkage porosity in practice.

In this work, production of ductile iron grinding table with weight of 142 t was introduced. Casting process was optimized based on ProCAST and melt treatment with cored wire injection and inoculation in the pouring basin was used to obtain a qualified casting.

Experimental Procedure

The melting process was carried out in medium frequency induction furnaces with 60t-12t-12t and 60t-30t-12t in capacity. Furnace charges for the selected composition were pig iron, steel scrap, and carbon additive. Raw materials with fewer impurities were used. Chemical composition was strictly controlled and nominal composition of the casting is 3.6%C, 1.9%Si, <0.2%Mn, <0.025%P and <0.015%S. After melting was finished, the chemical compositions of the metal were adjusted according to the results of spectrometry analysis done on a coin sample. The melt was then heated to 1500°C—1510°C to destroy any possible pre-existing nuclei. Slag was removed from the melt surface before being poured into two preheated ladles with 75 t in capacity.

*Corresponding author, email: xgdiao@126.com

Specimen for mechanical properties is cut from a 75 mm thick block attached to the casting. Each datum was averages of three tensile tests. Metallographic samples were taken directly from the tensile test specimens. Optical microscopy was performed after standard metallographic procedure on polished and etched specimens. The matrix structure is obtained following application of a nital (4% HNO₃ in ethanol solution) etch for 20 seconds.

Results and Discussion

Simulation of casting process

Fig. 1 shows the geometry and dimensions of the ductile iron grinding table casting. Diameter of the casting is more than $\Phi 6000$ mm and height of the casting is 2456 mm. Its minimum wall thickness is 200 mm while maximum wall thickness exceeds 300 mm. The diameter of hotspot is $\Phi 573$ mm. EN-GJS-400-15U was used in place of cast steel in our practice. The casting would be rejected if any casting defect exceeding grade 3 is found after UT detection according to EN 12680-3-2003.

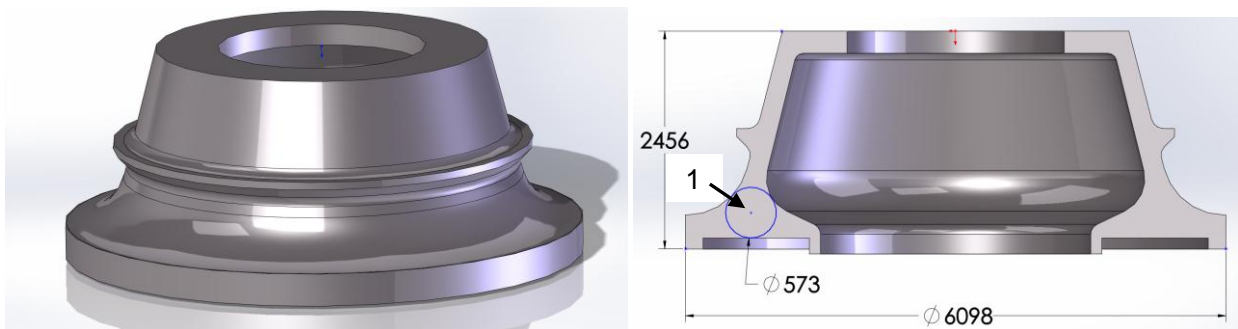

Fig.1: Geometry and dimensions of ductile iron grinding table (dimensions in mm)

Advanced simulation could be used to better understand and control such a complex solidification behavior. A commercial software ProCAST is used to predict solidification defects of the ductile iron casting. The pouring temperature at the gating inlet is 1330°C while ambient temperature is 30°C. The solidus and liquidus temperature are used as 1143°C and 1187°C, respectively. The other properties of the material, e.g. conductivity, density, viscosity, enthalpy and solid fraction are dependent upon the temperature based on ProCAST.

Fig. 2 gives simulated cooling curve of the last solidified area at the lower part of the grinding table. It is more than 28 h after the casting fully solidified, thus it leads to graphite degeneration, shrinkage porosity, etc. There exists much shrinkage porosity in the last solidified area, as confirmed in Fig. 3.

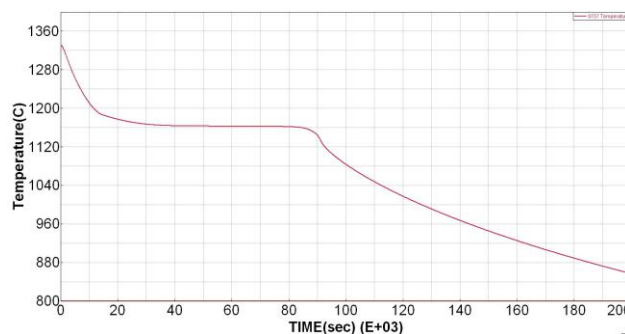

Fig.2: Simulated cooling curve of point 1 at thermal center.

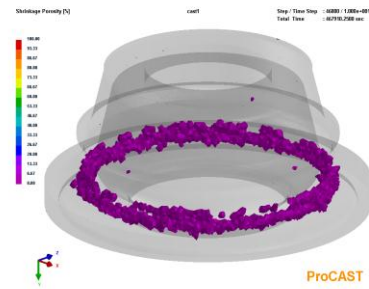

Fig.3: Shrinkage porosity prediction of the casting.

Fig.4 shows scheme diagram of an optimized casting process. Bottom-gated gating system was used and risers were set on the top of the casting. Cooling rate plays a significant role in reducing solidification time and hence shrinkage porosity of ductile iron. In order to reduce solidification time, chills are normally used, especially for a heavy section ductile iron casting. Therefore chills were set on the heavy section locations in order to make the casting solidify in sequence. Solidification time of the last solidified area (point 1 in Fig.1) reduce to about 4h, as shown in Fig.5. Short solidification time and sequence solidification help the reduction of shrinkage porosity area ratio of the casting compared with no chill used (see Fig.3 and Fig.6).

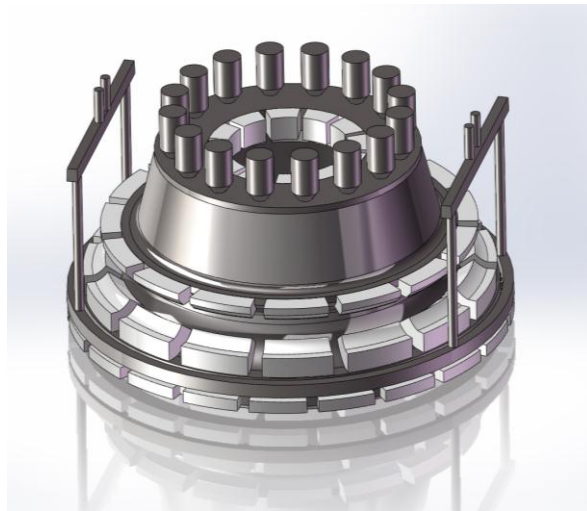

Fig.4: Schematic diagram of casting process.

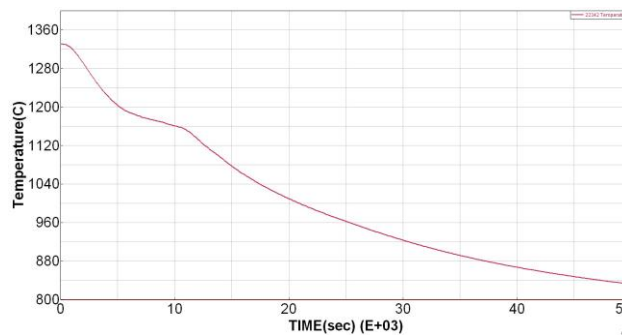

Fig.5: Cooling curve of point 1 at thermal center after casting process optimization.

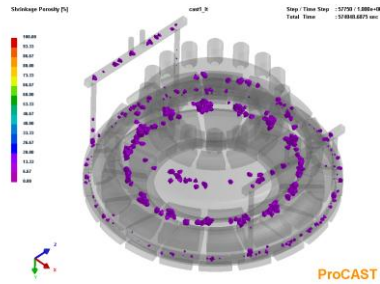

Fig.6: Shrinkage porosity prediction of the casting after casting process optimization.

Spheroidal and inoculation treatment

Heavy section ductile iron presents a unique metallurgical challenge, which can affect a casting's microstructure and shrinkage porosity. Spheroidal and inoculation treatment is very important to its microstructure and mechanical properties of ductile iron casting.

Although conventional sandwich process is used widely up to now, it is better to adopt wire feeding method instead for an extra large ductile iron casting. Fig.7 gives nodulization and inoculation treatment process with wire feeding method. They were performed at a melt temperature of 1360°C -1380°C at the same time. The amount of tapped liquid iron was more than 150 tons. The pouring temperature was 1310~1330°C.

It appears that long time after the wire feeding leads to fading of the inoculant, increasing risk of graphite degeneration and carbide formation. Therefore, additional inoculants were added in the large pouring basin to inoculate uniformly, as shown in Fig.8. The number of graphite nodules increases with increasing graphite nucleus. The addition of inoculants is beneficial to obtain high graphite grade and improve mechanical properties of the casting. The composition of cast-on sample was (wt%): 3.47C, 1.87Si, 0.17Mn, 0.011S, 0.024P, 0.061Mg and 0.013RE.



Fig.7: Spheroidal and inoculation treatment process of the casting in the cored-wire injection station.



Fig.8: Inoculant in the large pouring basin.

Microstructure and Mechanical properties

Fig.9 presents the microstructures of a cast-on sample. The nodularity of the cast-on sample was 85%-90% and graphite nodules appear almost uniform in size and evenly distributed in the matrix. It is found that solidification time has a significant effect on the morphology and size of graphite. Increasing the cooling rate leads to fine graphitization and favors spheroidal graphite formation. Hence no degenerated graphite is found in the picture with the help of chills used during solidification. Most of the matrix is nearly ferrite structure, and less than 10%-15% pearlite can be observed in the microstructure, as shown in Fig. 9(b).

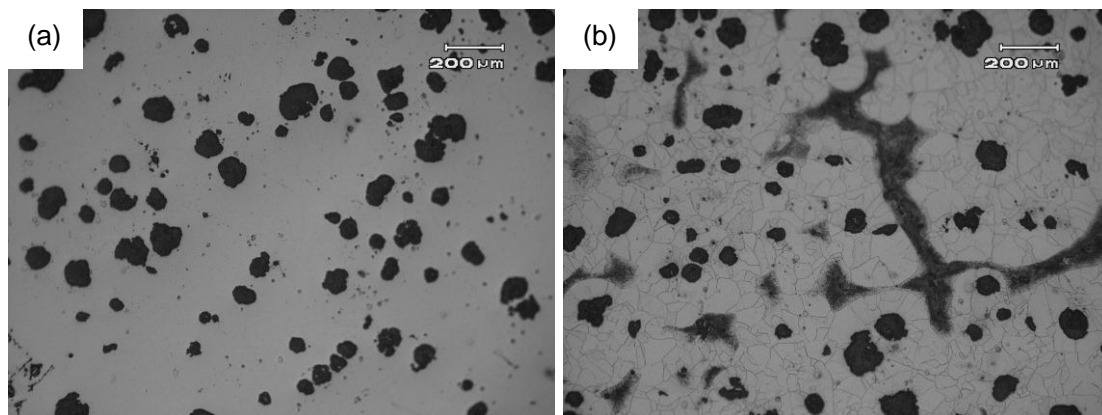

Fig.9: microstructures of ductile iron grinding table casting.
(a) unetched; (b) etched;

The mechanical properties measured are shown in Table 1. Tensile strength, elongation and hardness of the cast-on sample were above the requirements of EN-GJS-400-15U. Ultra-sonic test (UT) was performed and any casting defect exceeding grade 3 according to EN 12680-3-2003 was fully eliminated.

Table 1 Mechanical properties of the ductile iron grinding table.

	σ_b [MPa]	σ_s [MPa]	δ [%]	HB
target	≥ 370	≥ 240	≥ 12	120~180
No 1	412	291	14	169
No 2	407	285	16	160
No 3	405	282	15	162

Conclusions

1. Simulation is an effective way for a casting, especially extra large ductile iron casting. Both the cost and time is reduced and a qualified casting is obtained.
2. Shrinkage porosity can be reduced with the help of sequence solidification for a heavy section ductile iron casting.
3. Spheroidal and inoculation treatment is very important. Melt treatment with cored wire injection, and especially inoculation in the pouring basin is beneficial to its microstructure and mechanical properties of ductile iron casting
4. Ductile iron grinding table with good mechanical properties can replace cast steel casting.

References

1. C. Labrecque and M. Gagné: *Can. Metall. Quart.*, Vol. 1998, 37, 343-351.
2. M. You and X. Diao. *Advanced Materials Research*, 2012, 567, 141-145.
3. P. M. Cabanne, M. Gagne. *Ductile Iron and Wind Energy: A Symbiotic Relationship*. World Foundry Congress, Istanbul, 2004: 877-885.
4. D. M. Stefanescu, in *ASM Handbook*, eds. D. M. Stefanescu, N. Lillybeck (ASM International, 1998), Paper 625.
5. H. Itofuji, K. Kawamura, N. Hashimoto, H. Yamada, *AFS Transactions*, 1990, 43, 585-595.
6. K. F. Nilsson, M. Burstrom, F. Lofajand C. G. Andersson: *Eng. Fail. Anal.*, 2007, 14, 47-52
7. R. Källbom, K. Hamberg, M. Wessénand L. E. Björkegren: *Mater. Sci. Eng., A*, 2005, 413-414, 346-348
8. P. Minnebo, K. F. Nilssonand D. Blagoeva: *J. Mater. Eng. Perform.*, 2007, 16, 35-41
9. M. N. Ahmadabadi, E. Niyama, M. Tanino, T. Abe, and T. Ohide: *Metall. Mater. Trans. A*, 1994, 25, 911-917
10. L. Collini, G. Nicoletto, and R. Konecna: *Mater. Sci. Eng., A*, 2008, 488, 529-534
11. K. F. Nilsson and V. Vokal: *Mater. Sci. Eng., A*, 2009, 502, 54-58
12. P. K. Basutkar, C. R. Loper, and C. L. Babu: *AFS Trans.*, 1970, 78, 429-435
13. J. Wang, P. Fu, H.Liu, D. Li and Y.Li. *Mater. and Design*. 2012, 35, 446-456.
14. B. Pustal, B. Hallstedt, W. Schafer, C. Bartels, E. Subasic, H. Siebert, J. M. Schneider, and A. Buhrig-Polaczek: *Adv. Eng. Mater.*, 2010, 12, 158-169
15. D. M. Stefanescu: 'Computer simulation of shrinkage-related defects in castings - A review', 295-304; 2005, Warrendale, Minerals, Metals & Materials Soc.